

# Alfa Laval CB210 / CBH210

## Brazed plate heat exchanger

### Introduction

Alfa Laval CB brazed plate heat exchangers provide efficient heat transfer with a small footprint.

### Applications

- HVAC heating and cooling
- Refrigeration
- Oil cooling
- Industrial heating and cooling

### Benefits

- Compact
- Easy to install
- Self-cleaning
- Low level of service and maintenance is required
- All units are pressure and leak tested
- Gasket free

### Branded Features



**FlexFlow™**

Superior thermal performance



**PressureSecure**

Unparalleled strength for demanding duties



**ValuePlus**

Total support – with value-adding options to fit your needs

### Design

The brazing material seals and holds the plates together at the contact points ensuring optimal heat transfer efficiency and pressure resistance. Using advanced design technologies and extensive verification guarantees the highest performance and longest possible service life.

Different pressure ratings are available for different needs.

Asymmetric channels provide optimal efficiency in the most compact design.

Based on standard components and a modular concept, each unit is custom-built to meet the specific requirements of each individual installation.

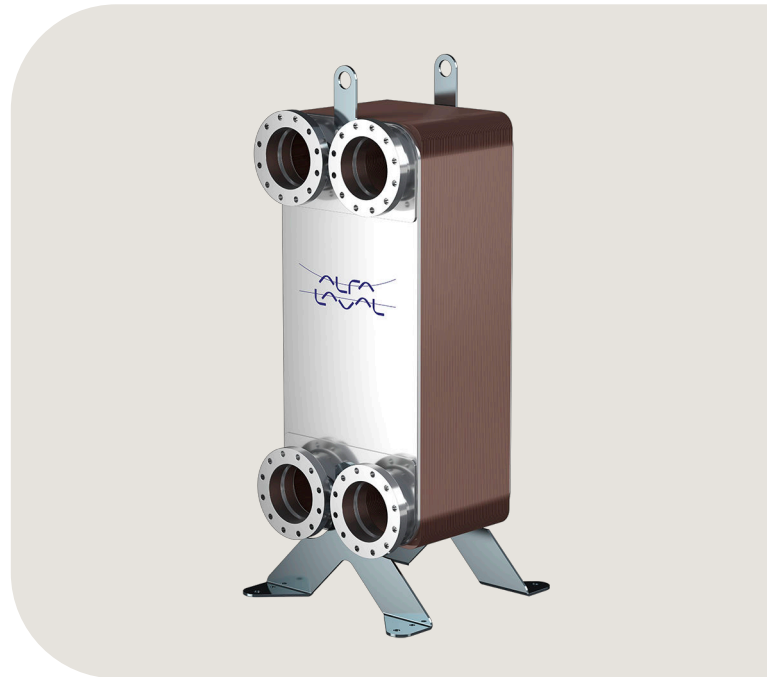

### Examples of connections



Compact flange

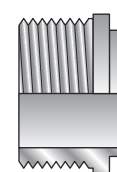
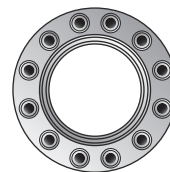

External thread

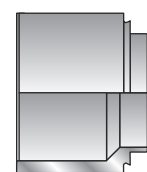

Welding

## Technical data

### Standard materials

Cover plates	Stainless steel
Connections	Stainless steel
Plates	Stainless steel
Brazing filler	Copper

## Dimensions and weight

### Dimensions and weight <sup>1</sup>

A measure (mm)	CB: $11 + (2.14 * n)$ CBH: $14 + (2.14 * n)$
A measure (inches)	CB: $0.43 + (0.08 * n)$ CBH: $0.55 + (0.08 * n)$
Weight (kg) <sup>2</sup>	CB: $12 + (0.61 * n)$ CBH: $14.5 + (0.61 * n)$
Weight (lb) <sup>2</sup>	CB: $26.46 + (1.34 * n)$ CBH: $31.97 + (1.34 * n)$

<sup>1</sup> n = number of plates

<sup>2</sup> Excluding connections

### Standard data

Volume per channel, litres (gal)	AH, AM: 0.636 (0.1680) H, L, M: 0.503 (0.1329)
Max. particle size, mm (inch)	1 (0.039)
Max. flowrate <sup>1</sup> m <sup>3</sup> /h (gpm)	162 (713.3)
Flow direction	Parallel
Min. number of plates	CB: 20 CBH: 20
Max. number of plates	CB: 360 CBH: 300

<sup>1</sup> Water at 5 m/s (16.4 ft/s) (connection velocity)

## Dimensional drawing

Measurements in mm (inches)

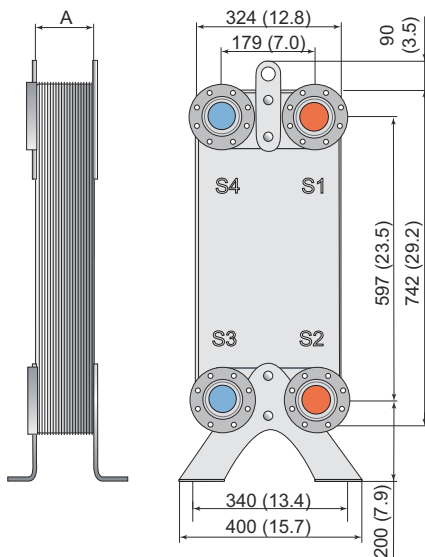

## Design pressure and temperature

### CB210/CBH210 – PED approval pressure/temperature graph

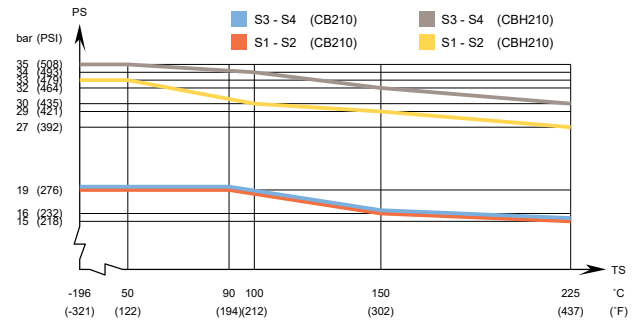

### CB210/CBH210 – UL approval pressure/temperature graph

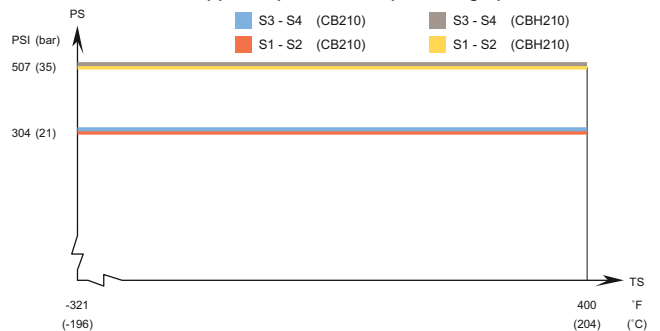

Designed for full vacuum.

Alfa Laval plate heat exchangers are available with a wide range of pressure vessel approvals. Please contact your Alfa Laval representative for more information.

**NOTE:** Values above are to be used as an indication. For exact values, please use the drawing generated by the Alfa Laval configurator or contact your local Alfa Laval representative.

## Marine approvals

CBMK210 can be delivered with marine classification certificate (ABS, BV, CCS, ClassNK, DNV-GL, KR, LR, RINA, RMRS)



**froztec.**

**FROZTEC INTERNATIONAL INC**  
DISTRIBUIDOR AUTORIZADO LATAM

www.froztec.com | info@froztec.com

This document and its contents are subject to copyrights and other intellectual property rights owned by Alfa Laval Corporate AB. No part of this document may be copied, re-produced or transmitted in any form or by any means, or for any purpose, without Alfa Laval Corporate AB's prior express written permission. Information and services provided in this document are made as a benefit and service to the user, and no representations or warranties are made about the accuracy or suitability of this information and these services for any purpose. All rights are reserved.