



Power COOL₂

Brochure

Industrial CO₂ transcritical pack systems



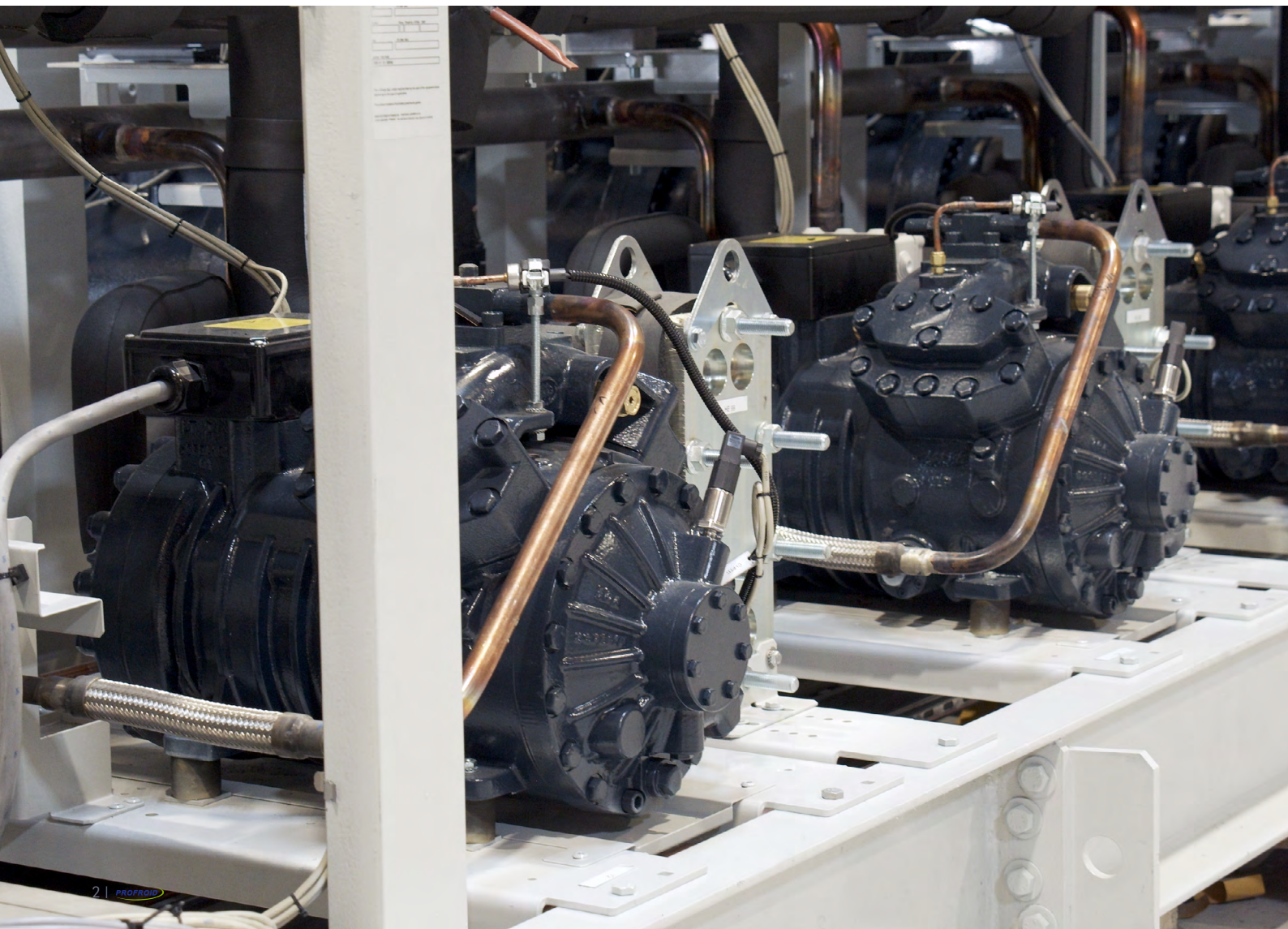
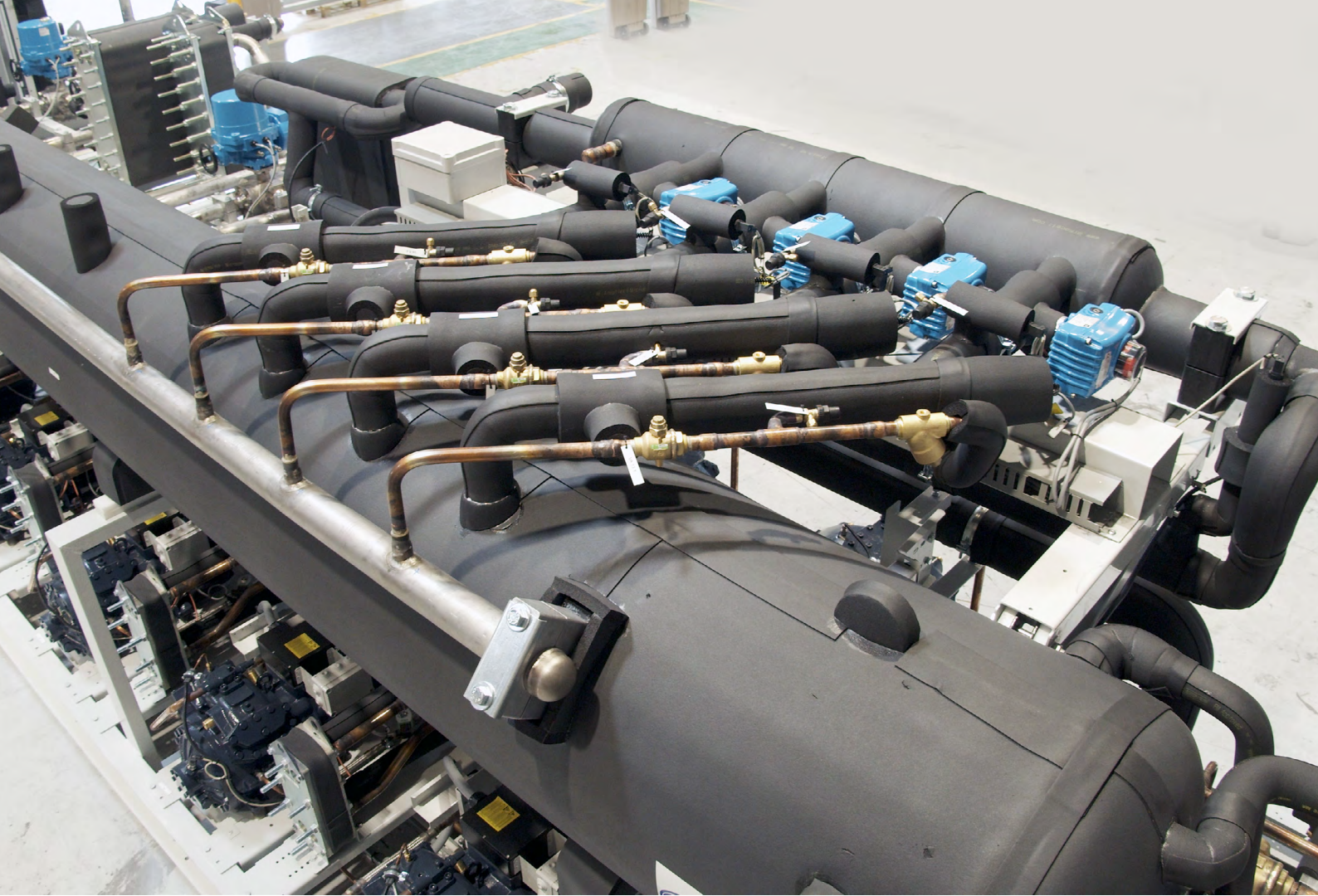

Summary

Main applications	4	Possible configurations	10
Preserving and recovering energy	5	Operating principles	12
▪ Preserving the environment	5	▪ Modulating vapor ejector	12
▪ Optimizing energy consumption	5	▪ Intermediate compression stage	12
▪ Recovering the heat produced	5	▪ Suction line heat exchanger (SLHX)	12
▪ Easier to use	5	▪ Semi-flooded mode	12
▪ User-friendly and connected control interface	5	▪ CO ₂ pump	12
▪ Faster approval, more incentives	5	▪ Heat recovery	12
▪ Wide range of applications	5	▪ PLC Controller	12
		▪ Receivers	12
		▪ Auxiliary condensing unit	12
Applications / Configurations / Temperatures	6	PLC interface and electrical enclosure	13
▪ Temperature range	6	▪ Download the app	13
		▪ Electrical cabinet	13
Components and connection points	7	▪ Control	13
Patented vapour ejector and system	8	Model designation	14
▪ Component	8	▪ Compressor list	14
▪ System	8	Selection table with dimensions	15
▪ Ejector advantages	8	Standard and options list	20
Heat reclaim possibilities	9		
▪ Enthalpy diagram of a heat recovery system	9		

Main applications

Warehouse & Distribution centers

- Warehouse
- Medium and low temperature
- Cold storage



- Competitive first investment and reduced service and maintenance cost
- Non-corrosive refrigerant; no risk for electric and electronic equipment
- Lower weight; reducing building and structural investment
- Hot gas defrost as an option for best possible energy performance

Process

- Food processing
- Meat processing
- Plastic industry



- Versions for pump assisted CO₂ secondary systems available
- Multiple heat recovery functions and heat pump versions available
- Compact, preassembled indoor and outdoor housed pack configurations for minimum on-site installation time

Sport venues

- Ice rink
- Ski arena



- Refrigerant allowed for use in public areas
- Direct expansion in the ice floor improving energy efficiency
- Precise control of ice quality
- Efficient heat recovery, high, medium and low grade flow specifically adapted for sports arenas

Heat pumps - A/C

- Domestic hot water
- Heating & hot water production
- District heating
- Comfort cooling A/C



- High grade flow temperature, up to 85 °C in standard version
- Non-flammable refrigerant
- Small footprint kW/m²
- High COP

Preserving and recovering energy



Preserving the environment

- GWP CO₂= 1
- Not flammable
- Not toxic
- Not corrosive



User-friendly and connected control interface

- Latest generation of PLC (programmable logic controller) with large touchscreen
- Embedded communication module
- Monitoring through webserver and smartphone app
- Included 4G router for remote commissioning and service



Optimizing energy consumption

- Up to 30% energy savings versus standard CO₂ systems
- Modulating vapor ejector (lower energy consumption, better temperature control)



Recovering the heat produced

- Up to 100% heat recovery (sanitary hot water and hot water for heating)
- Up to 2 MW of free heat
- 4 levels of heat recovery (up to 85°C, 45-60°C, 15-20°C)



Faster approval, more incentives

- No special approval needed from local authorities
- Eligible for incentives & subsidies in lots of European countries



Wide range of applications

- Distribution centers
- Food Processes
- Sport venues
- Heat pumps



Easier to use

- High-capacity with 1 rack
- Cooling capacity up to 700 kW LT*
- Cooling capacity up to 1.5 MW MT*
- Possibility to reach higher capacity by combining racks



* LT @-32°C / 37°C GC outlet
MT @-6°C / 37°C GC outlet

Applications / Configurations / Temperatures

PowerCO₂OL: a solution adapted to all your needs

MT = Medium Temperature | LT = Low Temperature | DX = Direct Expansion

Configurations	PowerCO ₂ OL MT DX	PowerCO ₂ OL MT Chiller	PowerCO ₂ OL MT+LT DX	PowerCO ₂ OL LT DX	PowerCO ₂ OL MT Chiller + LT DX	PowerCO ₂ OL MT (DX+Chiller) +LT DX	PowerCO ₂ OL Heat pump
Applications	Power 1	Power 2	Power 3	Power 4	Power 5	Power 6	Power 7
Distribution center	✓	✓	✓	✓			
Warehouse	✓	✓	✓	✓			
Hypermarket	✓	✓	✓				
Food processing	✓	✓	✓	✓	✓	✓	
Tunnel freezer			✓	✓			
Heating		✓					✓
Air conditioning		✓					✓
Sport venues	✓	✓					✓
Ice rink	✓	✓					✓

Configuration	Power 1	Power 2	Power 3	Power 4	Power 5	Power 6	Power 7
Cooling capacity MT* (kW)	350-1500	300-1250	350-1100	-	297-920	297-920	411-1172
Cooling capacity LT* (kW)	-	-	117-700	214-700	117-700	117-700	-
Heating capacity (kW)	2200	1950	1650	1350	1400	1400	2100
MT compressors	8	8	6	6	6	6	8
LT compressors	0	0	6	6	6	6	0

* @-6°C(MT)/-32°C(LT)/37°C (gas cooler outlet) for DX configuration
 @-8/-4°C(Chiller)/37°C (gas cooler outlet) for Chiller
 @+4°C(MT)/ 30-85°C Water temp for heat pump configuration

Temperature range

Ambient condition	Gascooler outlet	Evaporating temperature	PowerCO ₂ OL MT DX	PowerCO ₂ OL MT Chiller	PowerCO ₂ OL MT+LT DX	PowerCO ₂ OL LT DX	PowerCO ₂ OL MT Chiller + LT DX	PowerCO ₂ OL MT (DX+Chiller) +LT DX	PowerCO ₂ OL Heat pump	
			Power 1	Power 2	Power 3	Power 4	Power 5	Power 6	Power 7	
-35°C to +43°C	Min: +5°C/40bar Design point: +38°C/97bar Max: +45°C/102 bar	MT	Min.	-20°C	-20°C	-20°C	optimized by control	-20°C	-20°C	-20°C
			Design point	-4°C	-4°C	-4°C		-4°C	-4°C	+5°C
			max.	+4°C	+4°C	+4°C		+4°C	+4°C	+9°C
		LT	Min.			-45°C	-45°C	-45°C	-45°C	
			Design point			-32°C/ -4°C	-32°C/ -4°C	-32°C/ -4°C	-32°C/ -4°C	
			max.			-20°C	-20°C	-20°C	-20°C	

Note: Power4: Open flash + separate Chiller module.

Components and connection points

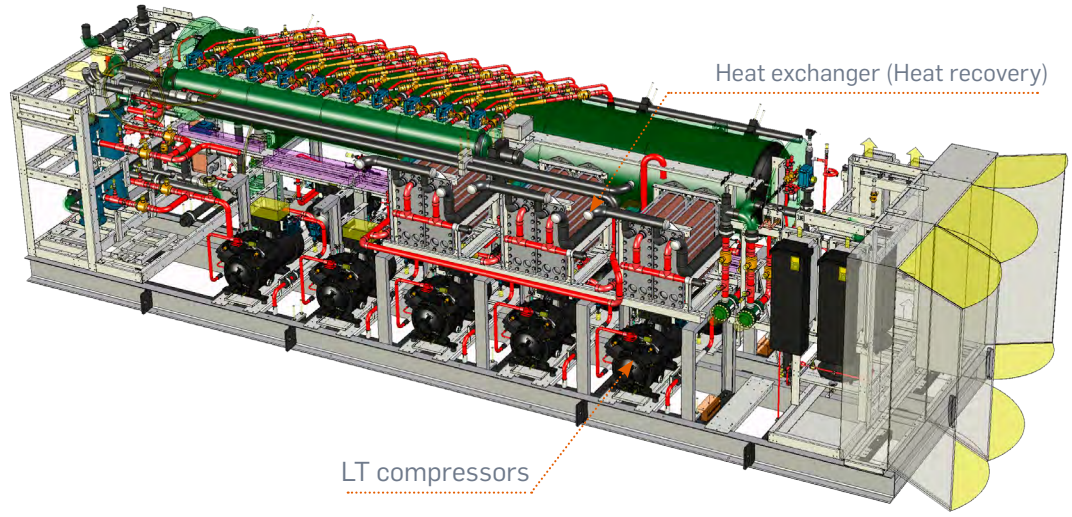
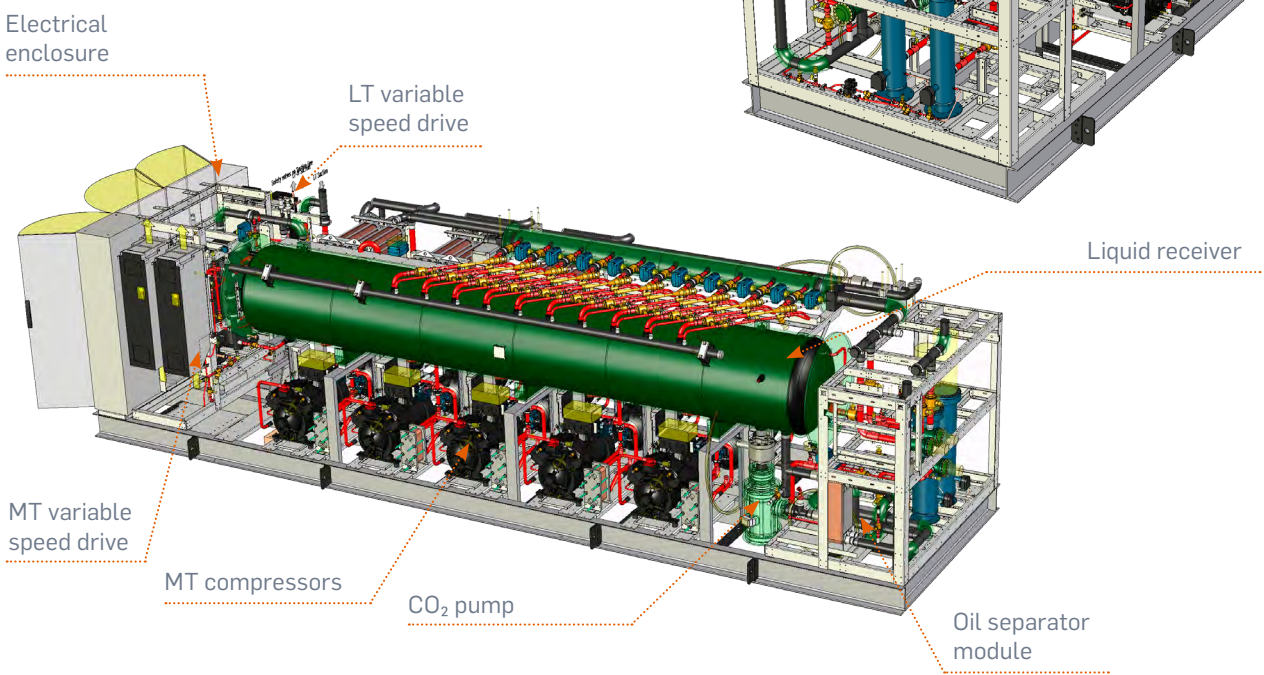
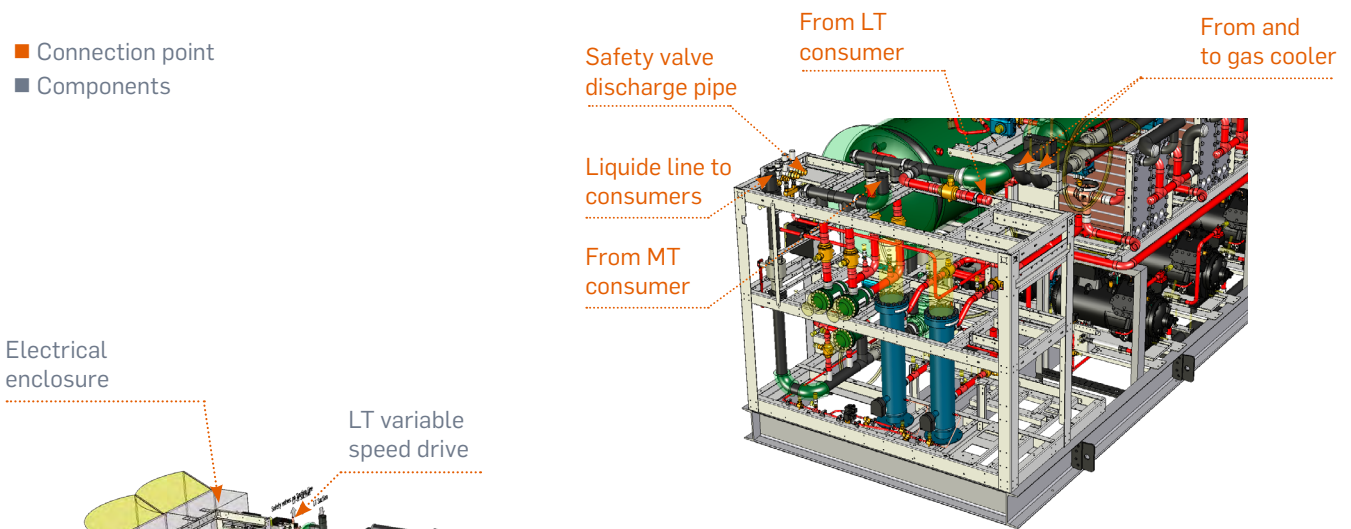
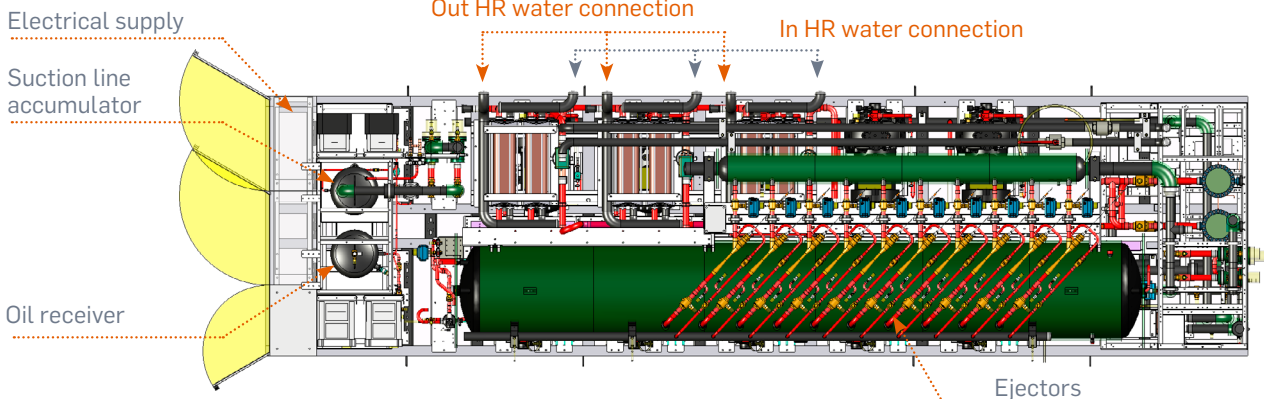

Patented vapour ejector and system

Our PowerCO₂OL range is equipped with the latest modulating ejector technology. This enables us to operate the compressors at a higher suction pressure while maintaining the cooling condition required from the system. In combination with flooded evaporator operation enabled by the PowerCO₂OL system design, the units provide significantly improved COP and reduced energy consumption. The system is designed to be compact while accessible with indoor and outdoor versions available. PowerCO₂OL can operate as a chiller or direct expansion solution with all components selected and designed for high system resilience.

Component

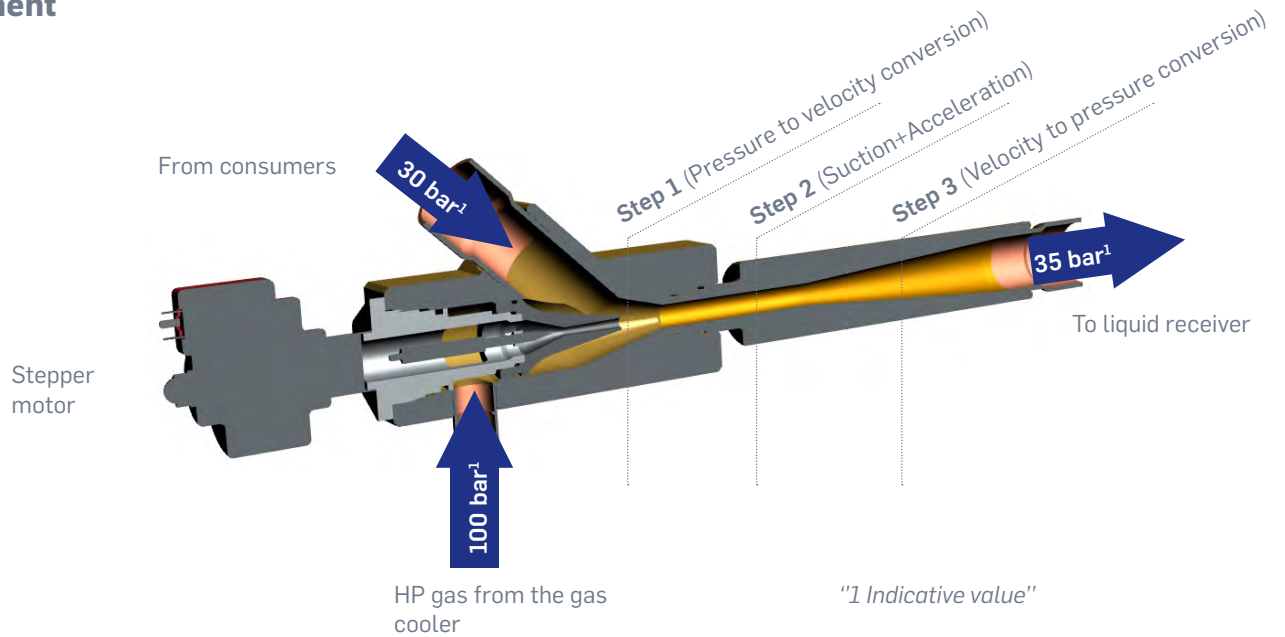

System

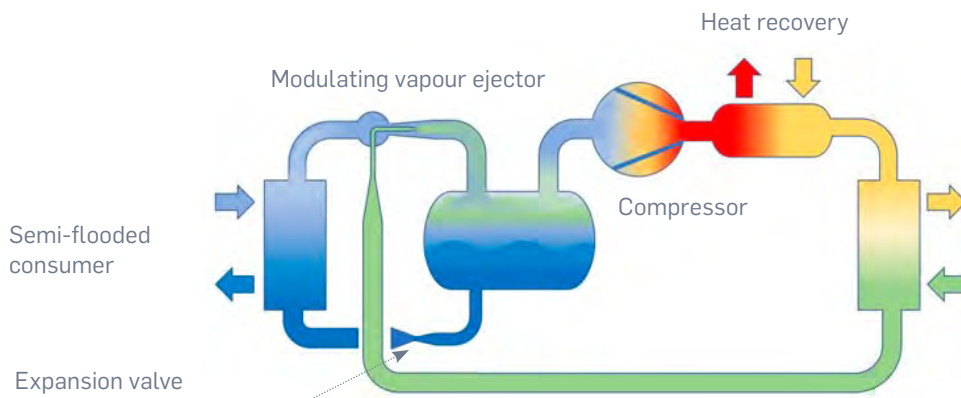

Ejector advantages

Standard transcritical system

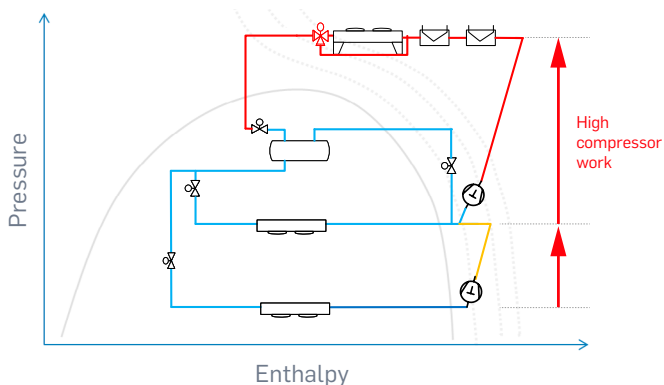

PowerCOOL₂

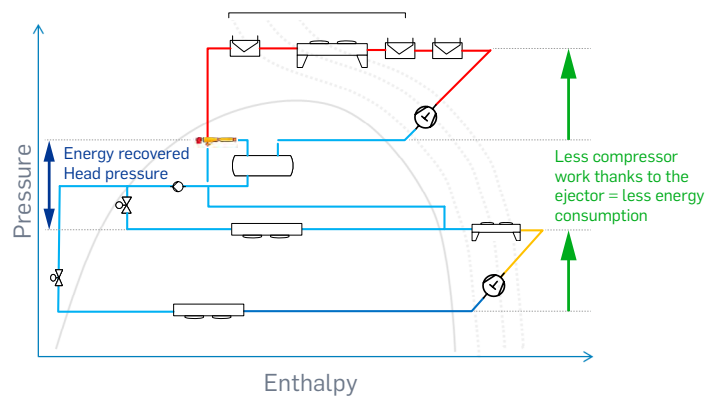

Heat reclaim possibilities

- | | | | | |
|--|---|--|--|---|
| <p>HE10</p> <ul style="list-style-type: none"> ▪ High grade heat recovery (sanitary hot water) | <p>HE20</p> <ul style="list-style-type: none"> ▪ Medium grade heat recovery (Heating) | <p>HE30</p> <ul style="list-style-type: none"> ▪ Air cooled gas cooler | <p>HE40</p> <ul style="list-style-type: none"> ▪ Low grade heat recovery (floor heating) | <p>HE130</p> <ul style="list-style-type: none"> ▪ Low grade heat recovery (floor heating) |
|--|---|--|--|---|

Enthalpy diagram of a heat recovery system

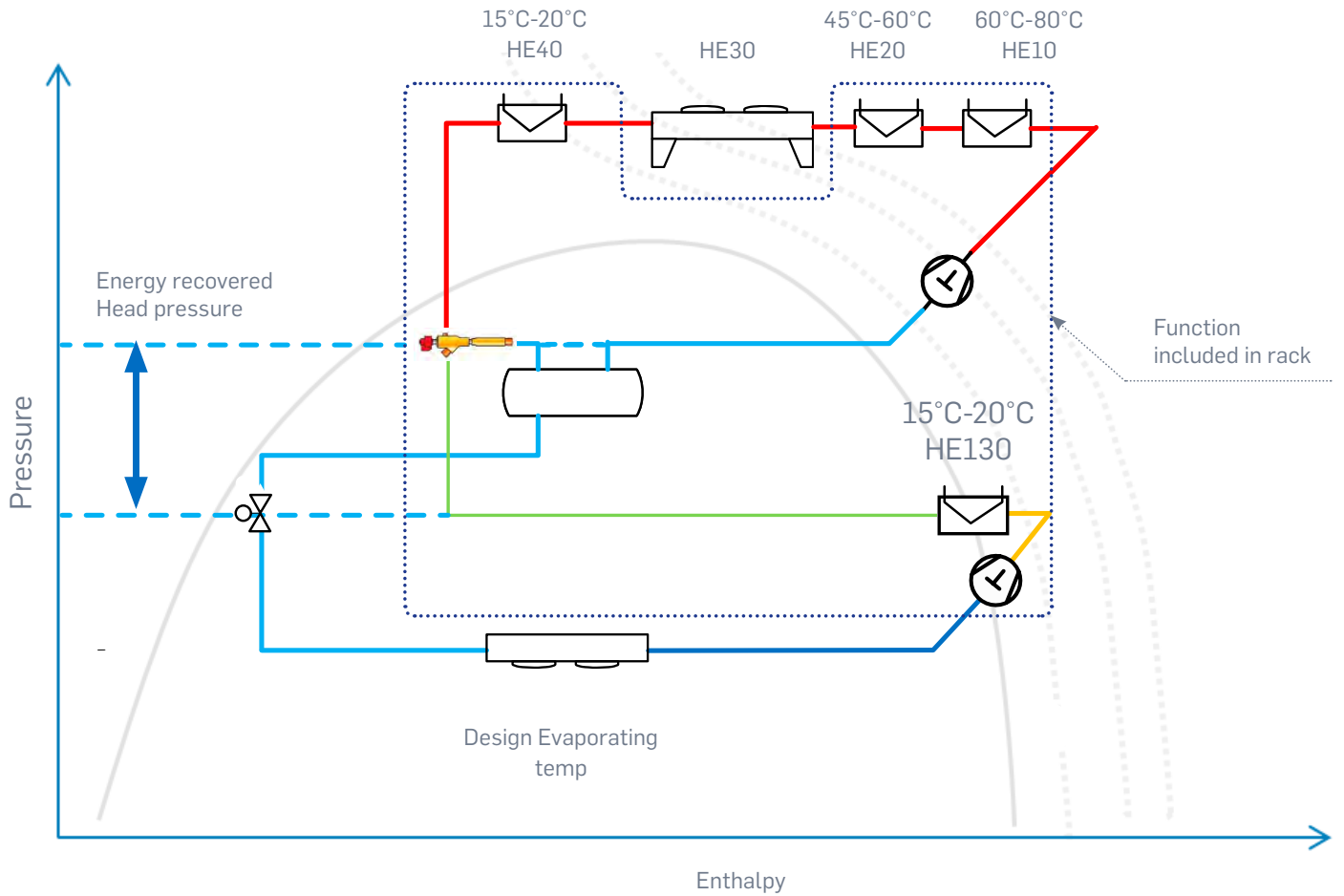

Possible configurations

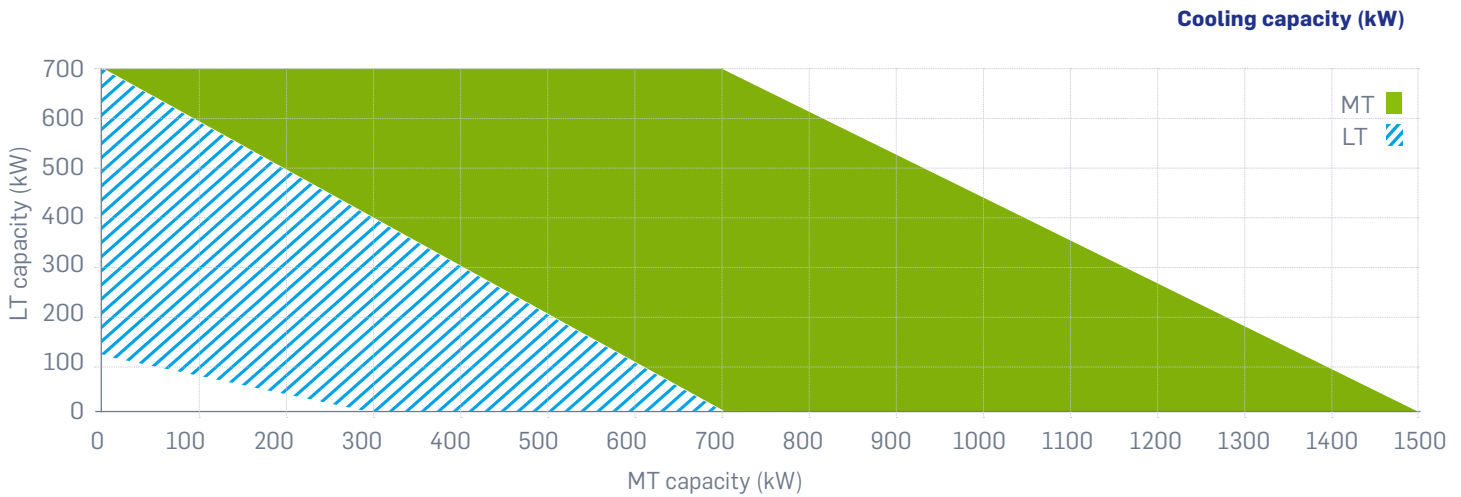

Power 1

PowerCO₂OL MT DX

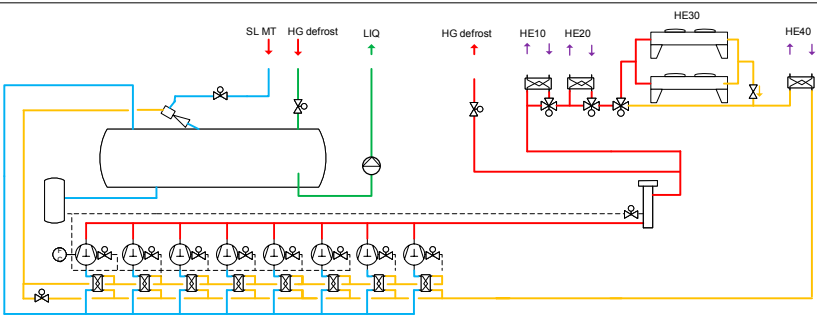

Cooling capacity

@ -6°C/37°C (gas cooler outlet)

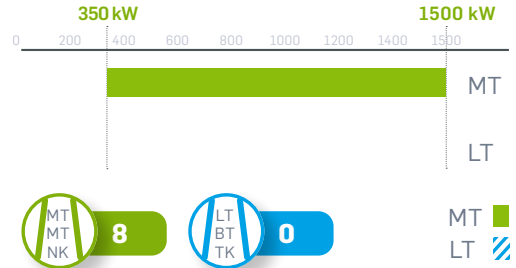

Power 2

PowerCO₂OL MT Chiller

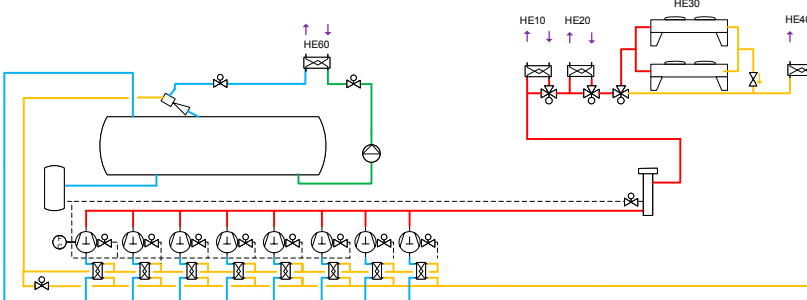

Cooling capacity

@ -8/-4°C(Chiller)/37°C (gas cooler outlet) for Chiller

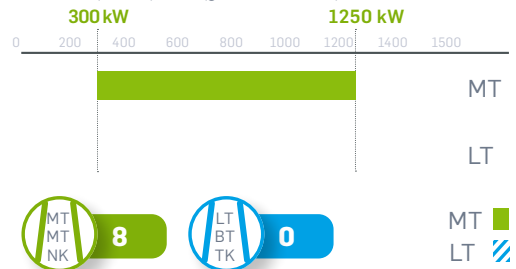

Power 3

PowerCO₂OL MT+LT DX

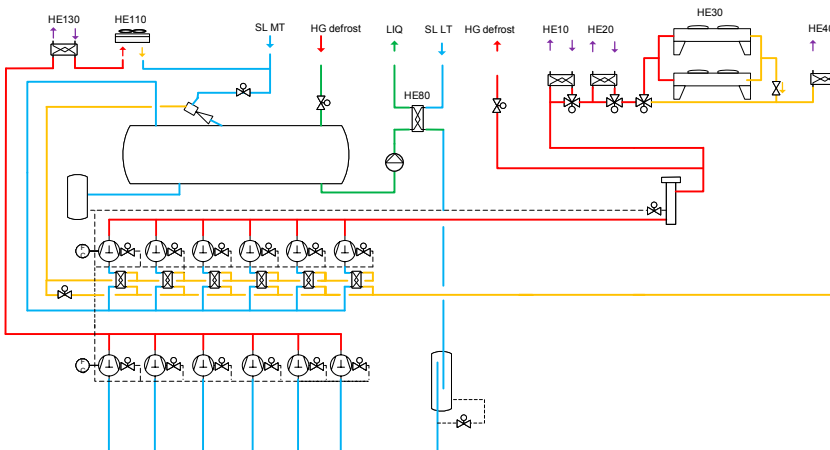

Cooling capacity

@ -6°C(MT)/-32°C(LT)/37°C (gas cooler outlet)

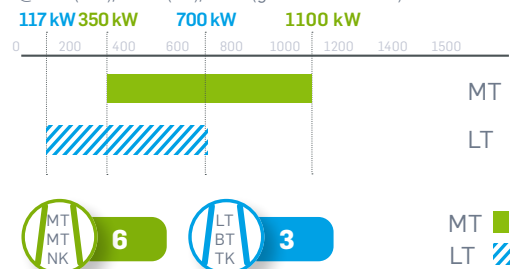

Power 4

PowerCO₂ OL LT DX

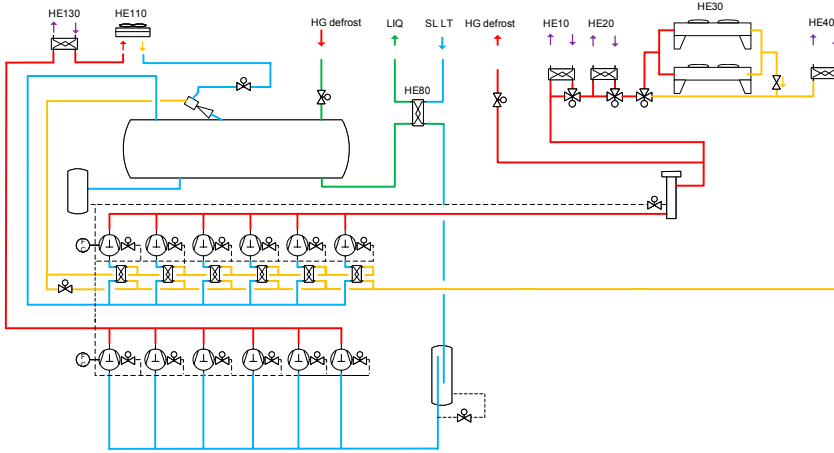

Cooling capacity

@-32°C(LT)/37°C (gas cooler outlet)

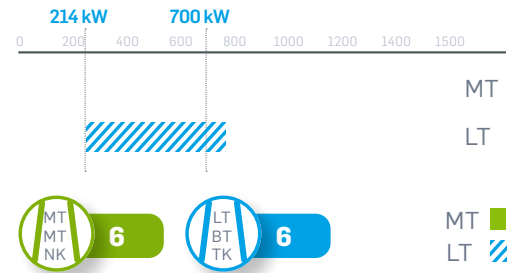

MT ■
LT ▨

Power 5

PowerCO₂ OL MT Chiller + LT DX

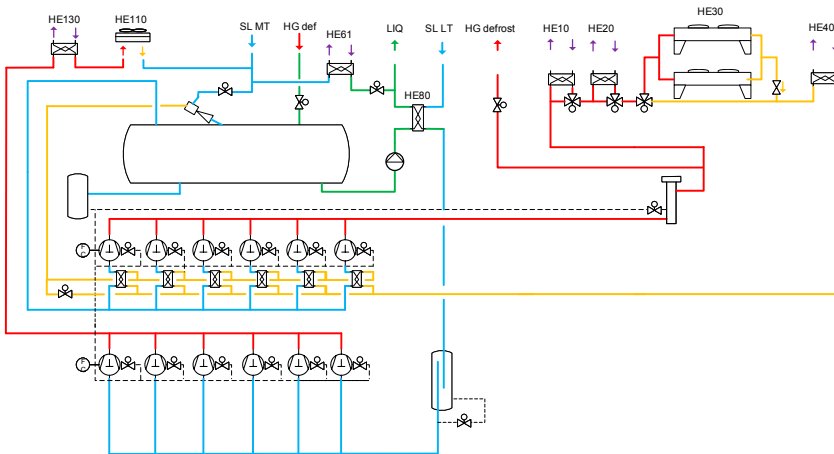

Cooling capacity

-8°C/-4°C(Chiller)/-32°C(LT)/37°C (gas cooler outlet)

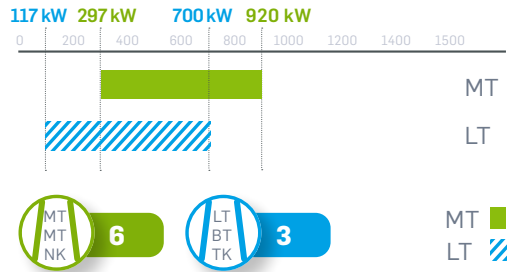

MT ■
LT ▨

Power 6

PowerCO₂ OL MT (DX+Chiller) + LT DX

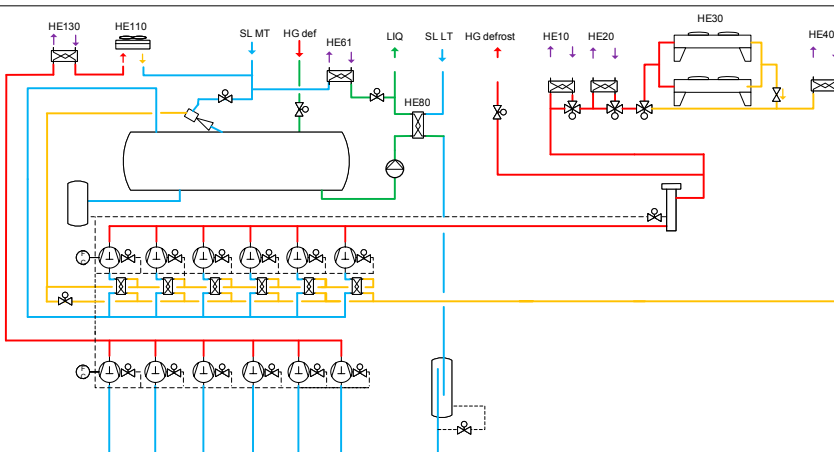

Cooling capacity

@-6°C(MT)/ -8°C/-4°C(Chiller) /-32°C(LT)/37°C (gas cooler outlet)

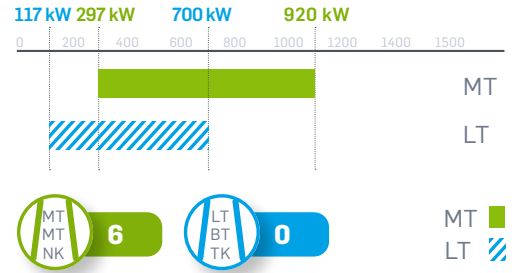

MT ■
LT ▨

Power 7

PowerCO₂ OL MT Heat pump

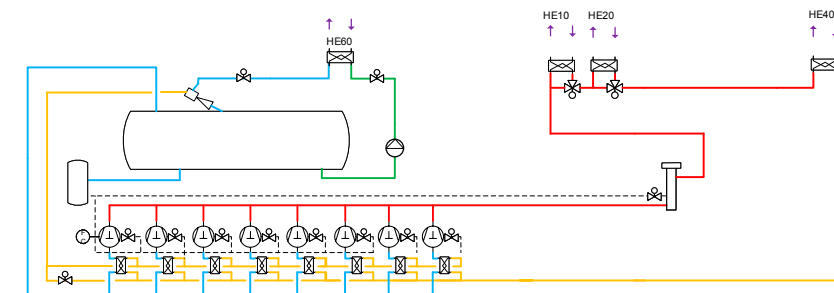

Heating capacity

@+4°C(MT)/ 30-85°C Water temp for heat pump configuration

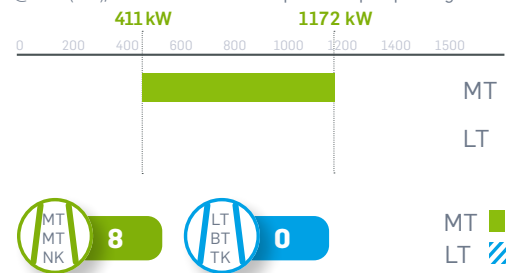

MT ■
LT ▨

Operating principles

In addition to using a neutral and natural refrigerant for the planet, PowerCO₂OL products integrate the latest innovative technology in order to enhance the energy efficiency and to minimize the carbon footprint linked to their use. The PowerCO₂OL differentiates itself from a standard transcritical solution in the following way:



Modulating vapor ejector

- On this range of machines there is no HP (high pressure) valve or MP (medium pressure) valve. The modulating vapor ejector recovers the energy from the high pressure circuit (coming from the gas cooler) to pre-compress the vapors coming from the MT consumers into the liquid receiver. Thus the ejectors replace the HP valve



Intermediate compression stage

- The MP stage compressor suction is entirely connected to the receiver. There is no MP expansion device. The pre-compression achieved by the ejectors allows to reduce the MP stage compressor work thus their electrical consumption



Suction line heat exchanger (SLHX)

- Each rack has its own heat exchanger to subcool the refrigerant exiting the gascooler and to generate superheat reducing the risk of liquid droplets going into the compressor



Semi-flooded mode

- The use of ejectors allows the MT evaporators operation to be in semi-flooded mode
- The LT consumers can also operate in semi-flooded mode. This will require the option "HE80" liquid subcooling exchanger in addition to the LT suction line receiver supplied as standard
- To benefits of the semi flooded mode, expansion valve with adapted orifice, set with 1 or 2K superheat are required. Standard evaporators can be used, no need of special coil for flooded mode



CO₂ pump

- The CO₂ pump is located after the liquid receiver, it is activated to compensate the limited pressure uplift achieved by the ejectors under certain outside temperature/pressure conditions (Winter without heat recovery or intermediate seasons). The pump ensures thus a regular supply to the MT consumers expansion valve
- The CO₂ pump is not operating continuously, it is enabled by the controller only if there is a risk that the expansion valve cannot provide enough cooling capacity

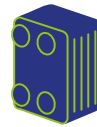

Heat recovery

- CO₂ and its excellent thermodynamic properties including high discharge gas temperatures, allows to recover up to 100% of the heat generated and on a continuous basis at high temperature. These features mean the system can simultaneously produce heat for space/floor heating and domestic hot water through several heat exchangers. Various configurations are possible with or without bypass gas-cooler and can be equipped with a set of anti boiling bypass valves. Pressure drop on water side calculated lower than 50 kPa



PLC Controller

- Intuitive HMI graphical display with easy access to running parameters and set points making commissioning, fine tuning and trouble shooting easier
- Built in methods for calculating and displaying cooling capacity, COP, generated heat etc. The PowerCO₂OL PLC controller helps to improve the installation and energy savings. Cooling/Heat recovery power and energy the connectivity of the installation (individual and combined) are calculated by using compressor polynomials, results are shown as values but also in a live Ph-log diagram
- Compatible with the main communication protocol networks (Modbus, Canbus, Bacnet...)



Receivers

- Horizontal receiver Internally equipped with liquid separation mesh and baffles, oil separation functionality and vortex prevention for the liquid outlet
- Insulated with 19mm Armaflex
- Safety valves on 3-way change over valve connected to a common discharge header



Auxiliary condensing unit

- Recommended only when using plate and gasket evaporator heat exchanger with 60 bar max service pressure

PLC interface and electrical enclosure

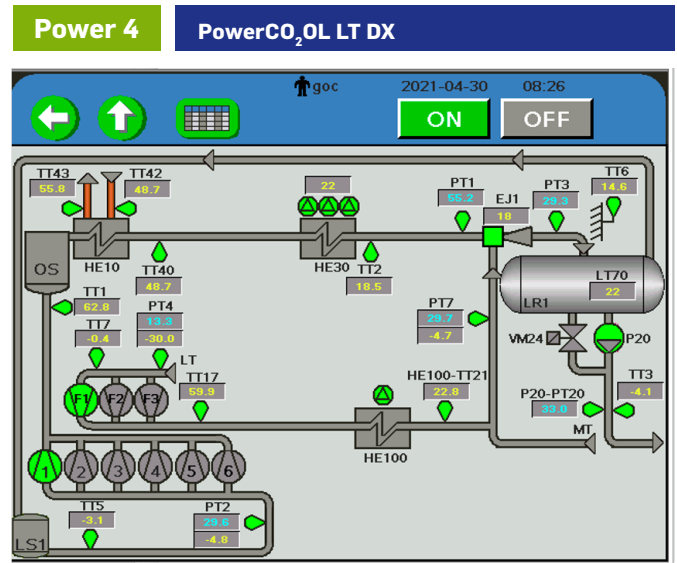
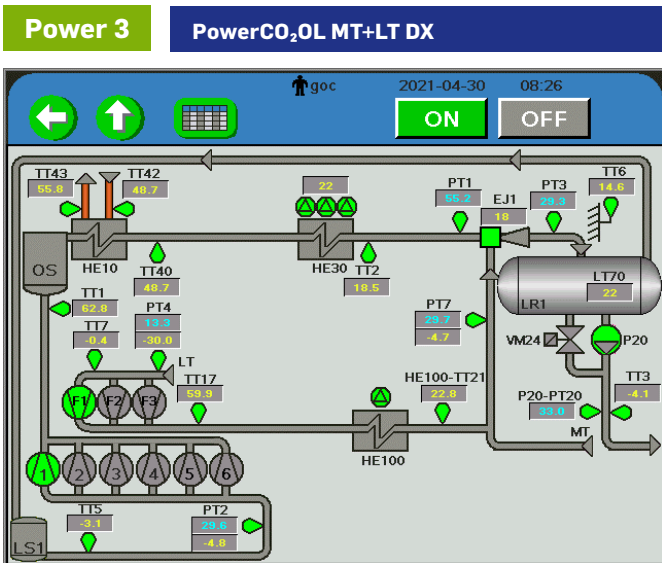

Download the app

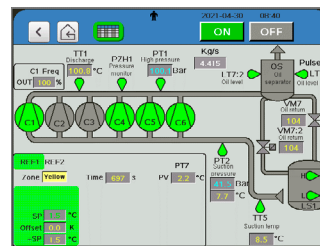

Compressors control

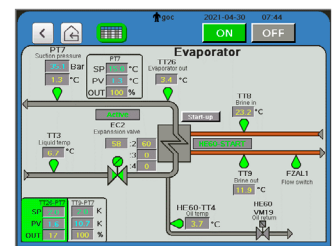

Evaporator control

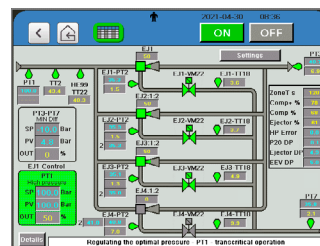

Ejector control

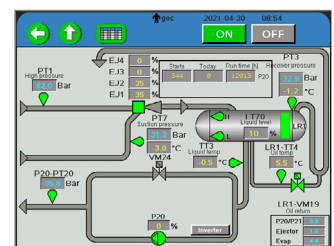

CO₂ pump control

Electrical cabinet

- Power supply
- Contactors
- Thermal protections
- Relays
- Terminal blocks
- Compressor power and management.
- Protection by adjustable thermal-magnetic circuit breaker
- A 400V + N power supply for the gas-cooler box

Control

- Control units and plant management PLCs
- Interactive touch screen mounted on the front panel
- Heat recovery control with control of 3-way valves and control of the pump on the water circuit
- 0-10V or MODBUS gas cooler fan control

Model designation

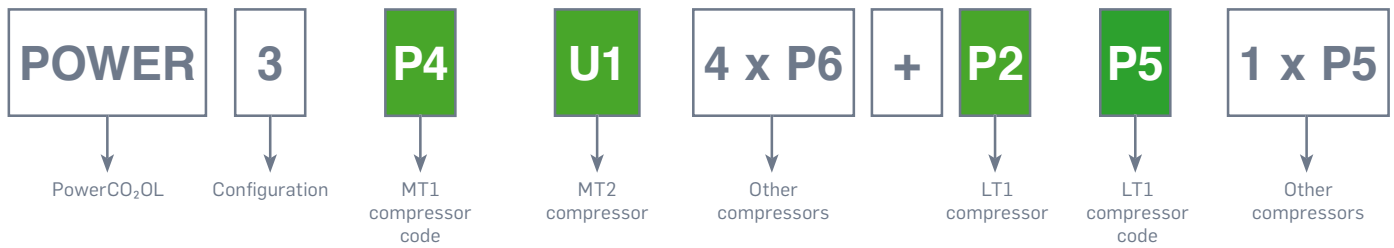

Compressor list

	Code	Brand	Model	Displacement (m ³ /h)	Absorbed power Pa (kW) @50Hz	I _{max} (A)	Cooling capacity Q ₀ (kW)	Absorbed power Pa* (kW)
	E2	Dorin	CD2000M/OP	13,84 m ³ /h	14,72 kW	38,00 A	31,4 kW	15,9 kW
	F6	Dorin	CD2400H/OP	13,84 m ³ /h	18,40 kW	45,00 A	31,5 kW	16,4 kW
	F7	Dorin	CD2500H/OP	15,72 m ³ /h	18,40 kW	45,00 A	35,4 kW	18,6 kW
	E3	Dorin	CD2500M	17,84 m ³ /h	18,40 kW	45,00 A	40,8 kW	20,6 kW
	F8	Dorin	CD3000H	17,84 m ³ /h	22,08 kW	56,00 A	40,9 kW	21,2 kW
	A8	Dorin	CD3001M	20,25 m ³ /h	25,76 kW	56,00 A	46,8 kW	23,8 kW
	A9	Dorin	CD3401H	20,25 m ³ /h	25,76 kW	75,00 A	46,8 kW	24,3 kW
	C2	Dorin	CD3501H	23,25 m ³ /h	25,76 kW	75,00 A	52,9 kW	27,9 kW
	C3	Dorin	CD3501M	26,45 m ³ /h	25,76 kW	75,00 A	61,0 kW	31,7 kW
	C4	Dorin	CD4501H	26,45 m ³ /h	46,50 kW	80,00 A	59,8 kW	31,8 kW
	H1	Dorin	CD5001M	31,00 m ³ /h	36,80 kW	93,00 A	71,8 kW	37,1 kW
	G3	Dorin	CD5201M	35,47 m ³ /h	34,12 kW	93,00 A	82,3 kW	42,6 kW
	P3	Dorin	CD6 601-40M	39,85 m ³ /h	70,00 kW	105,00 A	94,4 kW	48,5 kW
	U1	Dorin	CD6 701-40H	39,85 m ³ /h	81,90 kW	120,00 A	95,6 kW	48,7 kW
	P6	Dorin	CD6 701-45M	45,34 m ³ /h	81,90 kW	120,00 A	107,3 kW	55,4 kW
	P4	Dorin	CD6 801-45H	45,34 m ³ /h	92,00 kW	148,00 A	108,6 kW	55,6 kW
	P7	Dorin	CD6 801-53M	53,21 m ³ /h	92,00 kW	148,00 A	125,7 kW	65,2 kW
	P1	Dorin	CD6 901-53H	53,21 m ³ /h	92,00 kW	148,00 A	127,1 kW	65,4 kW
R8	Dorin	CD6 901-59M	59,53 m ³ /h	51,58 kW	148,00 A	140,4 kW	73,2 kW	

*@ -8°C/+32°C (89bar) kW; 34°C sortie Gas cooler

	G9	Dorin	CD1200B (LA)	13,84 m ³ /h	8,83 kW	14,00 A	28,2 kW	5,5 kW
	D2	Dorin	CD1200B/OP	13,84 m ³ /h	8,83 kW	28,00 A	28,2 kW	5,5 kW
	H4	Dorin	CD2000M (LA)	13,84 m ³ /h	14,72 kW	17,00 A	28,6 kW	5,5 kW
	W4	Dorin	CD1500B (LA)	15,72 m ³ /h	11,04 kW	19,00 A	32,4 kW	6,3 kW
	D3	Dorin	CD1500B/OP	15,72 m ³ /h	11,04 kW	34,00 A	32,4 kW	6,3 kW
	H5	Dorin	CD2500M (LA)	17,84 m ³ /h	18,40 kW	23,00 A	37,2 kW	7,1 kW
	A6	Dorin	CD2001B	20,20 m ³ /h	14,72 kW	38,00 A	43,1 kW	8,1 kW
	W5	Dorin	CD2001B (LA)	20,20 m ³ /h	14,72 kW	21,00 A	43,1 kW	8,1 kW
	G6	Dorin	CD3001M (LA)	20,25 m ³ /h	25,76 kW	26,00 A	43,1 kW	8,1 kW
	C1	Dorin	CD2501B	23,25 m ³ /h	18,40 kW	45,00 A	49,9 kW	9,4 kW
	G7	Dorin	CD2501B (LA)	23,25 m ³ /h	18,40 kW	26,00 A	49,9 kW	9,4 kW
	W7	Dorin	CD3501M (LA)	26,45 m ³ /h	25,76 kW	32,00 A	55,9 kW	10,8 kW
	A7	Dorin	CD3001B	26,57 m ³ /h	22,08 kW	56,00 A	56,8 kW	10,9 kW
	W6	Dorin	CD3001B (LA)	26,57 m ³ /h	22,08 kW	30,00 A	56,8 kW	10,9 kW
	H3	Dorin	CD5001M (LA)	31,00 m ³ /h	36,80 kW	35,00 A	65,9 kW	12,5 kW
	C5	Dorin	CD3501B	31,04 m ³ /h	25,76 kW	75,00 A	66,2 kW	12,4 kW
	G8	Dorin	CD3501B (LA)	31,04 m ³ /h	25,76 kW	32,00 A	66,2 kW	12,4 kW
	G5	Dorin	CD5201M (LA)	35,47 m ³ /h	34,12 kW	37,00 A	75,5 kW	14,3 kW
	G2	Dorin	CD4001B	35,50 m ³ /h	29,44 kW	80,00 A	75,7 kW	14,2 kW
	G4	Dorin	CD4001B (LA)	35,50 m ³ /h	29,44 kW	35,00 A	75,7 kW	14,2 kW
	P2	Dorin	CD6 501-40B	39,85 m ³ /h	58,50 kW	90,00 A	83,9 kW	15,4 kW
	M5	Dorin	CD6 501-40B (LA)	39,85 m ³ /h	58,50 kW	45,70 A	83,9 kW	15,4 kW
P5	Dorin	CD6 501-45B	45,34 m ³ /h	58,80 kW	90,00 A	95,2 kW	17,4 kW	
W2	Dorin	CD6 501-45B (LA)	45,34 m ³ /h	58,80 kW	49,90 A	95,2 kW	17,4 kW	
P9	Dorin	CD6 501-53B	53,21 m ³ /h	58,80 kW	90,00 A	111,9 kW	20,3 kW	
S8	Dorin	CD6 501-53B (LA)	53,21 m ³ /h	83,00 kW	55,80 A	111,9 kW	20,3 kW	
T2	Dorin	CD6 601-59B (LA)	59,53 m ³ /h	83,00 kW	55,80 A	124,5 kW	22,6 kW	

*@ -32°C/-8°C; 34°C sortie Gas cooler

CE marking compliant with 2014/68/UE PED Directive.

Selection table with dimensions

DX VERSION										
Configuration	Compressor		Dimensions	Component arrangement						Frame
	MT Compressor number	LT Compressor number	Length (mm)	E.Box	VSD + oil	Compressors Receiver HR			Oil sep + service pipes	
POWER 1 PowerCO₂OL MT DX	3	0	6450	E.Box		HR	HR	HR	Oil SEP. + Service	A
						Oil rec.	Rec. 950/1800 L			
						VSD MT	M1	M2	M3	
	4	0	6450	E.Box		M4	HR	HR	Oil SEP. + Service	A
						Oil rec.	Rec. 950/1800 L			
						VSD MT	M1	M2	M3	
	5	0	6450	E.Box		M4	HR	HR	Oil SEP. + Service	A
						Oil rec.	Rec. 950/1800 L			
					VSD MT	M1	M2	M3		
6	0	6450	E.Box		M4	HR	HR	Oil SEP. + Service	A	
					Oil rec.	Rec. 950/1800 L				
					VSD MT	M1	M2	M3		
7	0	7395	E.Box		M5	HR	HR	Oil SEP. + Service	B	
					Oil rec.	Rec. 950/1200/1800 L				
					VSD MT	M1	M2	M3	M4	
8	0	7395	E.Box		M5	HR	HR	Oil SEP. + Service	B	
					Oil rec.	Rec. 950/1200/1800 L				
					VSD MT	M1	M2	M3	M4	
7	0	8340	E.Box		M6	HR	HR	Oil SEP. + Service	C	
					Oil rec.	REC.1200/1800/2633 L				
					VSD MT	M1	M2	M3	M4	M5
8	0	8340	E.Box		M6	HR	HR	Oil SEP. + Service	C	
					Oil rec.	REC.1200/1800/2633 L				
					VSD MT	M1	M2	M3	M4	M5

Modules color codes :

CHILLER
RECEIVER
MT COMPRESSOR
LT COMPRESSOR
OIL SEPARATOR
E-BOX (400mm)
VSD + OIL RECEIVERS + SL ACCUMULATOR
HEAT RECOVERY

Frame A

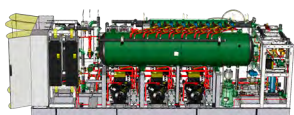

6450

Frame B

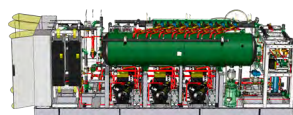

7395

Frame C

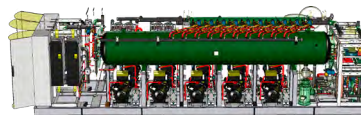

8340

Frame D

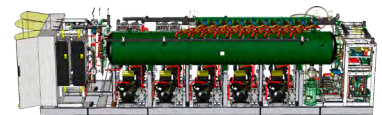

9285 mm

All Frames: Width = 2200 mm, Height = 2200 mm

Selection table with dimensions

DX VERSION												
Configuration	Compressor		Dimensions	Component arrangement							Frame	
	MT Compressor number	LT Compressor number		E.Box	VSD + oil	Compressors Receiver HR			Oil sep + service pipes			
POWER 2 PowerCO ₂ OL MT Chiller	3	2	6450	E.Box	VSD LT	L1	L2		Oil SEP. + Service		A	
	SL REC.	HR	HR		HR							
	Oil rec.	Rec. 950/1800 L										
	VSD MT	M1	M2		M3							
	3	3	6450	E.Box	VSD LT	L1	L2	L3	Oil SEP. + Service		A	
	SL REC.	HR	HR		HR							
	Oil rec.	Rec. 950/1800 L										
	VSD MT	M1	M2		M3							
	4	2	6450	E.Box	VSD LT	L1	L2	M4	Oil SEP. + Service		A	
	SL REC.	HR	HR		HR							
	Oil rec.	Rec. 950/1800 L										
	VSD MT	M1	M2		M3							
	4	3	7395	E.Box	VSD LT	L1	L2	L3	Oil SEP. + Service		B	
	SL REC.	HR	HR		HR							
Oil rec.	Rec. 950/1200/1800 L											
VSD MT	M1	M2	M3		M4							
4	4	7395	E.Box	VSD LT	L1	L2	L3	L4	Oil SEP. + Service		B	
SL REC.	HR	HR		HR								
Oil rec.	Rec. 950/1200/1800 L											
VSD MT	M1	M2		M3	M4							
5	2	7395	E.Box	VSD LT	L1	L2	M5	Oil SEP. + Service		B		
SL REC.	HR	HR		HR								
Oil rec.	Rec. 950/1200/1800 L											
VSD MT	M1	M2		M3	M4							
5	3	7395	E.Box	VSD LT	L1	L2	L3	M5	Oil SEP. + Service		B	
SL REC.	HR	HR		HR								
Oil rec.	Rec. 950/1200/1800 L											
VSD MT	M1	M2		M3	M4							
5	4	8340	E.Box	VSD LT	L1	L2	L3	L4	Oil SEP. + Service		C	
SL REC.	HR	HR		HR								
Oil rec.	REC.1200/1800/2633 L											
VSD MT	M1	M2		M3	M4	M5						
5	5	8340	E.Box	VSD LT	L1	L2	L3	L4	L5	Oil SEP. + Service		C
SL REC.	HR	HR		HR								
Oil rec.	REC.1200/1800/2633 L											
VSD MT	M1	M2		M3	M4	M5						
6	2	7395	E.Box	VSD LT	L1	L2	M5	M6	Oil SEP. + Service		B	
SL REC.	HR	HR		HR								
Oil rec.	Rec. 950/1200/1800 L											
VSD MT	M1	M2		M3	M4							
6	3	8340	E.Box	VSD LT	L1	L2	L3	M6	Oil SEP. + Service		C	
SL REC.	HR	HR		HR								
Oil rec.	REC.1200/1800/2633 L											
VSD MT	M1	M2		M3	M4	M5						
6	4	8340	E.Box	VSD LT	L1	L2	L3	L4	M6	Oil SEP. + Service		C
SL REC.	HR	HR		HR								
Oil rec.	REC.1200/1800/2633 L											
VSD MT	M1	M2		M3	M4	M5						
6	6	9285	E.Box	VSD LT	L1	L2	L3	L4	L5	L6	Oil SEP. + Service	D
SL REC.	HR	HR		HR								
Oil rec.	REC.1200/1800/2633 L											
VSD MT	M1	M2		M3	M4	M5	M6					

DX VERSION

Configuration	Compressor		Dimensions	Component arrangement						Frame			
	MT Compressor number	LT Compressor number	Length (mm)	E.Box	VSD + oil	Compressors Receiver HR			Oil sep + service pipes				
POWER 4 PowerCO₂OL LT DX	3	3	6450	E.Box	VSD LT	L1	L2	L3	Oil SEP. + Service	A			
					SL REC.	HR	HR	HR					
					Oil rec.	Rec. 950/1800 L							
					VSD MT	M1	M2	M3					
	4	4	7395	E.Box	VSD LT	L1	L2	L3	L4	Oil SEP. + Service	B		
					SL REC.	HR	HR	HR					
					Oil rec.	Rec. 950/1200/1800 L							
					VSD MT	M1	M2	M3	M4				
	5	5	8340	E.Box	VSD LT	L1	L2	L3	L4	L5	Oil SEP. + Service	C	
					SL REC.	HR	HR	HR					
					Oil rec.	REC.1200/1800/2633 L							
					VSD MT	M1	M2	M3	M4	M5			
	6	6	9285	E.Box	VSD LT	L1	L2	L3	L4	L5	L6	Oil SEP. + Service	D
					SL REC.	HR	HR	HR					
					Oil rec.	REC.1200/1800/2633 L							
					VSD MT	M1	M2	M3	M4	M5	M6		

Modules color codes :

CHILLER
RECEIVER
MT COMPRESSOR
LT COMPRESSOR
OIL SEPARATOR
E-BOX (400mm)
VSD + OIL RECEIVERS + SL ACCUMULATOR
HEAT RECOVERY

Frame A

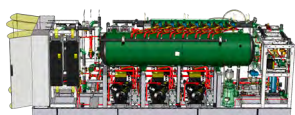

6450

Frame B

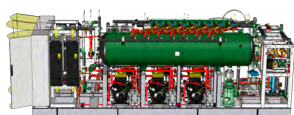

7395

Frame C

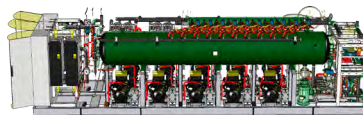

8340

Frame D

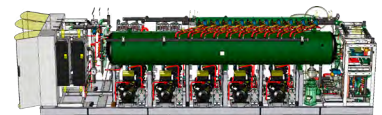

9285 mm

All Frames: Width = 2200 mm, Height = 2200 mm

Selection table with dimensions

CHILLER VERSION with Brazed plate heat exchanger CBXP (Gasket plate heat exchanger will be separate module)											
Configuration	Compressor		Dimensions	Component arrangement							Frame
	MT Compressor number	LT Compressor number		E.Box	VSD + oil	Compressors Receiver HR			Oil sep + service pipes		
POWER 2 PowerCO ₂ OL MT Chiller / POWER 7 PowerCO ₂ OL MT Heat pump	3	0	6450	E.Box		HR	HR	BPHX	Oil SEP. + Service	A	
					Oil rec.	Rec. 950/1800L					
					VSD MT	M1	M2	M3			
						M4		BPHX	Oil SEP. + Service	A	
				Oil rec.	Rec. 950/1800L						
				VSD MT	M1	M2	M3				
						M4	M5	BPHX	Oil SEP. + Service	A	
				Oil rec.	Rec. 950/1800L						
			VSD MT	M1	M2	M3					
					M5	M6	HR	Oil SEP. + Service	B		
			Oil rec.	Rec. 950/1200/1800L							
			VSD MT	M1	M2	M3	M4				
					M5	M6	M7	Oil SEP. + Service	B		
			Oil rec.	Rec. 950/1200/1800L							
			VSD MT	M1	M2	M3	M4				
					M5	M6	M7	Oil SEP. + Service	B		
			Oil rec.	Rec. 950/1200/1800L							
			VSD MT	M1	M2	M3	M4				
					M6	M7	HR	Oil SEP. + Service	C		
			Oil rec.	REC.1200/1800/2633L							
			VSD MT	M1	M2	M3	M4				
					M6	M7	M8	Oil SEP. + Service	C		
			Oil rec.	REC.1200/1800/2633L							
			VSD MT	M1	M2	M3	M4				

Modules color codes :

CHILLER	OIL SEPARATOR
RECEIVER	E-BOX (400mm)
MT COMPRESSOR	VSD + OIL RECEIVERS + SL ACCUMULATOR
LT COMPRESSOR	HEAT RECOVERY

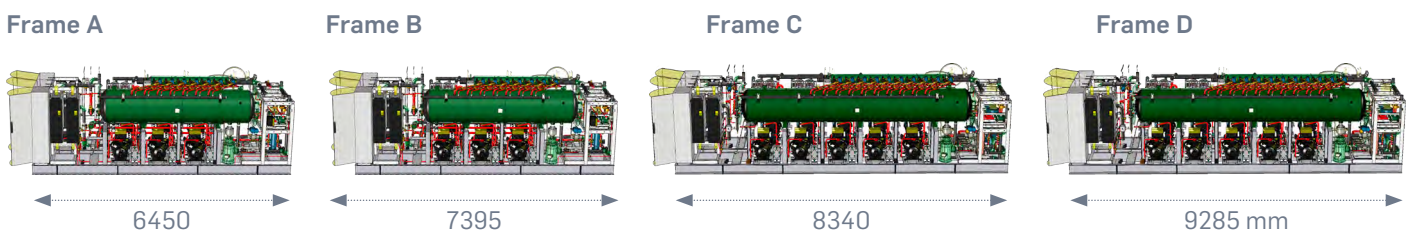

All Frames: Width = 2200 mm, Height = 2200 mm

CHILLER VERSION with Brazed plate heat exchanger CBXP (Gasket plate heat exchanger will be separate module)

Configuration	Compressor		Dimensions	Component arrangement							Frame	
	MT Compressor number	LT Compressor number		E.Box	VSD + oil	Compressors Receiver HR			Oil sep + service pipes			
POWER 5 PowerCO₂OL MT Chiller + LT DX / POWER 6 PowerCO₂OL MT (DX+Chiller) + LT DX	3	2	6450	E.Box	VSD LT	L1	L2	BPHX	Oil SEP. + Service	A		
	SL REC.	HR	HR		HR							
	Oil rec.	Rec. 950/1800L										
	VSD MT	M1	M2		M3							
	3	3	7395	E.Box	VSD LT	L1	L2	L3	BPHX	Oil SEP. + Service	B	
	SL REC.	HR	HR		HR							
	Oil rec.	Rec. 950/1200/1800L										
	VSD MT	M1	M2		M3							
	4	2	7395	E.Box	VSD LT	L1	L2		BPHX	Oil SEP. + Service	B	
	SL REC.	HR	HR		HR							
	Oil rec.	Rec. 950/1200/1800L										
	VSD MT	M1	M2		M3	M4						
4	3	7395	E.Box	VSD LT	L1	L2	L3	BPHX	Oil SEP. + Service	B		
SL REC.	HR	HR		HR								
Oil rec.	Rec. 950/1200/1800L											
VSD MT	M1	M2		M3	M4							
4	4	8340	E.Box	VSD LT	L1	L2	L3	L4	BPHX	Oil SEP. + Service	C	
SL REC.	HR	HR		HR								
Oil rec.	REC.1200/1800/2633L											
VSD MT	M1	M2		M3	M4							
5	2	7395	E.Box	VSD LT	L1	L2	M5	BPHX	Oil SEP. + Service	B		
SL REC.	HR	HR		HR								
Oil rec.	Rec. 950/1200/1800L											
VSD MT	M1	M2		M3	M4							
5	3	8340	E.Box	VSD LT	L1	L2	L3		BPHX	Oil SEP. + Service	C	
SL REC.	HR	HR		HR								
Oil rec.	REC.1200/1800/2633L											
VSD MT	M1	M2		M3	M4	M5						
5	4	8340	E.Box	VSD LT	L1	L2	L3	L4	BPHX	Oil SEP. + Service	C	
SL REC.	HR	HR		HR								
Oil rec.	REC.1200/1800/2633L											
VSD MT	C1	C2		C3	C4	C5						
5	5	9285	E.Box	VSD LT	L1	L2	L3	L4	L5	BPHX	Oil SEP. + Service	D
SL REC.	HR	HR		HR								
Oil rec.	REC.1200/1800/2633L											
VSD MT	M1	M2		M3	M4	M5						
6	2	8340	E.Box	VSD LT	L1	L2	C6		BPHX	Oil SEP. + Service	C	
SL REC.	HR	HR		HR								
Oil rec.	REC.1200/1800/2633L											
VSD MT	M1	M2		M3	M4	M5						
6	3	8340	E.Box	VSD LT	L1	L2	L3	M6	BPHX	Oil SEP. + Service	C	
SL REC.	HR	HR		HR								
Oil rec.	REC.1200/1800/2633L											
VSD MT	M1	M2		M3	M4	M5						
6	4	9285	E.Box	VSD LT	L1	L2	L3	L4	L5	BPHX	Oil SEP. + Service	D
SL REC.	HR	HR		HR								
Oil rec.	REC.1200/1800/2633L											
VSD MT	M1	M2		M3	M4	M5	M6					

Standard and options list

Configurations	PowerCO ₂ OL MT DX	PowerCO ₂ OL MT Chiller	PowerCO ₂ OL MT+LT DX	PowerCO ₂ OL LT DX	PowerCO ₂ OL MT Chiller + LT DX	PowerCO ₂ OL MT (DX+Chiller) +LT DX	PowerCO ₂ OL Heat pump
Applications	Power 1	Power 2	Power 3	Power 4	Power 5	Power 6	Power 7

Main function	Description	Power 1	Power 2	Power 3	Power 4	Power 5	Power 6	Power 7
general characteristics	Service pressure PS 80/80/80/120 (LT suction / MT suction / Receiver / Discharge (Bar)	●	X	●	●	X	●	X
	Service pressure PS 60/60/60/120 (LT suction / MT suction / Receiver / Discharge (Bar)	○	●	○	○	●	○	●
	Voltage 400V/3ph/50Hz				●			
	Stainless steel or K65 copper depending on the pressure/ diameter				●			
	Cold surface insulated 19 mm				●			
	Frame, RAL 7035				●			
	PAG oil pre charge, delivered in separate 20 liters cans				●			
compressors	Crankcase heater / mechanical oil pump / oil pressure sensor /Oil injection Solenoid valve with shut-off valve				●			
	Discharge temperature sensor / Safety High pressure switch (preset 120 bar) / pressure relief valve				●			
	Suction and Discharge Valve / Internal winding protection				●			
	Superheat suction line heat hexchanger HEX HE99 with VM20 suction temp control valve				●			
	Variable Speed Drive on compressor 1 MT and LT				●			
	Variable Speed Drive on compressor 2 MT and/ or LT				○			
	Soft mounting with vibration absorber and vibration eliminators				●			
Drip tray per compressor				●				
LT suction Line	LT suction accumulator	X	X	●	●	●	●	X
	HE48 LT Suction line Filter with shut-off valve	X	X	○	○	○	○	X
	EC7 second suction line LT including control valve	X	X	○	○	○	○	X
	LT flooded suction line heat exchanger HE 80	X	X	○	○	○	○	X
MT suction Line	HE48 MT Suction line Filter with shut-off valve	○	X	○	X	○	○	X
	EC8 second suction line MT including control valve	○	X	○	X	○	○	X
Discharge line	header 120 bar with 2 safety valves on change over valve				○			
	Hot gas defrost Ejector system from 50 -100- 200kW		X	○	○	○	○	X
Oil management	1 or 2 Oil separator with replacement filter ; with individual shut-off valve				●			
	Shut off valve + service valve + solenoid valve + oil filter with replacable cartridge on the oil line				○			
	Oil receiver with degasing line connected to liquid receiver				●			
	Oil strainer after oil sep and before Oil injection valve				●			
Liquid line and receiver	950 / 1200 / 1800 / 2633 Liters Horizontal receiver				●			
	Insulated with grease bandage / aluminum / Armaflex 19 mm				●			
	High and low level alams				●			
	Filter drier as by pass of the liquid line, with shut-off valve and service valve				●			
	LT70 - Liquid Level transmitter in receiver including dry column				○			
	Full assembly vapor EJECTOR from 3 to 10				●			
	CO ₂ liquid pump with In and out shut-off valve. Inverter driven motorized by-pass valve for the CO ₂ liquid pump when pump is not activated	●	●	●	X	●	●	●
Second pump as redundancy (separately delivered)	●	●	●	X	●	●	●	

● standard ○ option X not available

Main function	Description	Power 1	Power 2	Power 3	Power 4	Power 5	Power 6	Power 7
Chiller	HE61 Evaporator / chiller brazed Heat exchanger with expansion valve EC2	X	●	X	X	●	●	●
	HE62 Evaporator / chiller plate gasket Heat exchanger for high capacity or special fluids	X	●	X	X	●	X	●
	SOV, suction line temperature sensors for measurement values and freeze protection function	X	●	X	X	●	X	●
	HE60-P20, External 0-10V control signal	X	○	X	X	○	○	○
	PM6 - Power Meter - External pump	X	○	X	X	○	○	○
Heat recovery	HE10 High grade heat reclaim + insulation				○			
	Change over valve, Boil Protection HE10				○			
	HE10-P20, External 0-10V control signal				○			
	Digital input to start heat reclaim on HE10				○			
	HE20 Medium grade heat reclaim				○			
	Change over valve, Boil Protection HE20				○			
	HE20-VM3, External 0-10V control signal				○			
	Digital input to start heat reclaim on HE20				○			
	Change over valve, Bypass HE30 (gas cooler)	○	○	○	○	○	○	X
	Check Valve(s) after HE30 Gas cooler outlet - delivered lose	○	○	○	○	○	○	X
HE40 Subcooler / gas cooler	○	○	○	○	○	○	X	
HE40-P20, External 0-10V control signal	○	○	○	○	○	○	X	
HE130 LT discharge liquid cooled intercooler	X	X	○	○	○	○	X	
Safety	Main preset automatic high-pressure safety switch for medium temp. rack.				●			
	2 Headers for PRV's				○			
	Safety valve on change over valve (according to PED risk category)				●			
Outdoor housing	Outdoor housing (RAL7035)				○			
	Housing sound proofing				○			
	Air conditioned housing				○			
Electrical panel	Main switch, terminals, contactors, relays ,control. IP21				●			
	Short circuit protection 15 kA				●			
	Short circuit protection 25 kA / 35 /50kA				○			
	Other voltage	X	X	X	X	X	X	X
	PM1 - Power Meter - Total				○			
	PM2 - Power Meter - MT-Pack				○			
	PM3 - Power Meter - LT-Pack	X	X	○	○	○	○	X
	PM4 - Power Meter - Gas Cooler	○	○	○	○	○	○	X
	Lightning protection				○			
	Light and power socket inside electrical panel E 16A (France) or j 10A (Switzerland) or F16A Germany or 10A Australia				○			
Light and power socket inside electrical panel other type							on demand	

● standard ○ option X not available

Standard and options list

Main function	Description	Power 1	Power 2	Power 3	Power 4	Power 5	Power 6	Power 7
Control	Schneider PLC including a 7,5" display showing all pressures and temperatures, settings are adjustable in password protected sub-menus				•			
	Web server for internet connection to allow remote access / remote control is installed as standard				•			
	PLC Buffer module				○			
	UPS- Battery back up system				○			
	Spares kit PLC+Screen+1 comcard+ 1 module.				○			
	Digital output to force MT and/or LT expansion valves closure	○	X	○	○	○	○	X
	Digital input signal to start a defrost cycle				○			
	Set Point Offset on MT-pack (digital signal)	○	○	○	X	○	○	○
	Set Point Offset on MT-pack (analog signal)				○			
	Set Point Offset on LT-pack (analog signal)	X	X	○	○	○	○	X
	0-10V communication to gascooler				○			
	VM11 - Adiabatic control water spray system (signal only) ON/OFF	○	○	○	○	○	○	X
Co2ilclean modbus com gascooler (control and cleaning of gas cooler)	○	○	○	○	○	○	X	
Communication	Modbus RS485/RTU				○			
	Modbus TCP				○			
	Wurm Interface				○			
	RDM Interface				○			
	Ekelmann interface				○			
	Danfoss interface				○			
	Web server for internet connection to allow remote access / remote control is installed as standard				•			

• standard ○ option X not available



FROZTEC INTERNATIONAL INC
DISTRIBUIDOR AUTORIZADO LATAM

www.froztec.com | info@froztec.com

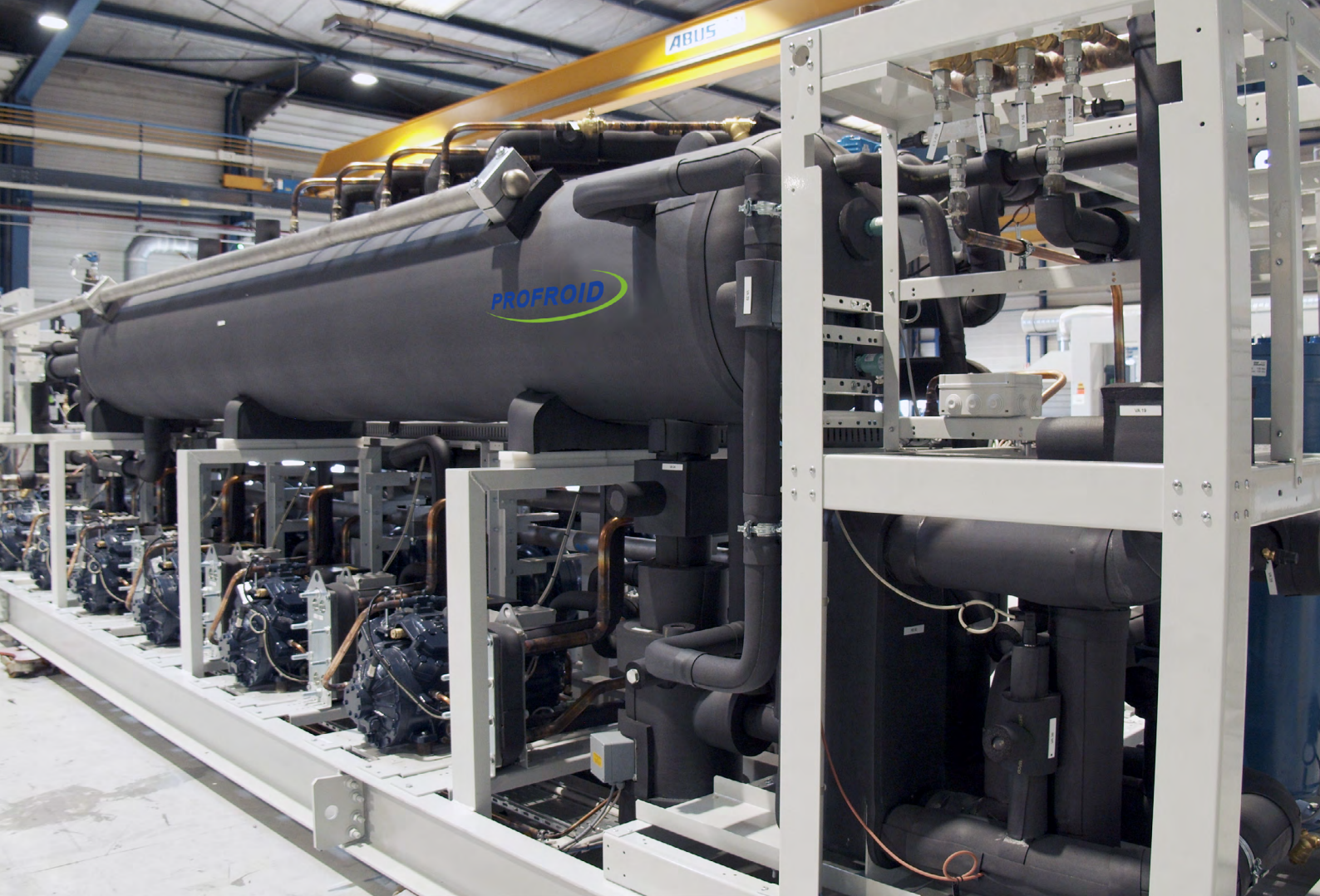

Discover our complete range of CO₂ solutions

PowerCO₂L

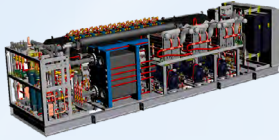

High capacity applications

QuietCO₂L



Store expansion
Small cold room

MaxiCO₂L compact



Distribution center

CO₂
REFRIGERANT
NATUREL

QuietCO₂LMC



Convenience store

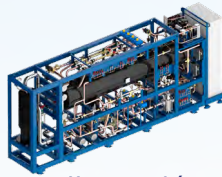

Hypermarché

COOLtecEvo

MiniCO₂L compact



Supermarket

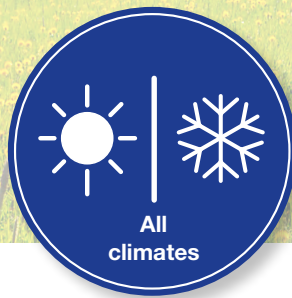

More than

18 000₂ units produced

60
years
1961-2021

PROFROID



www.profroid.com